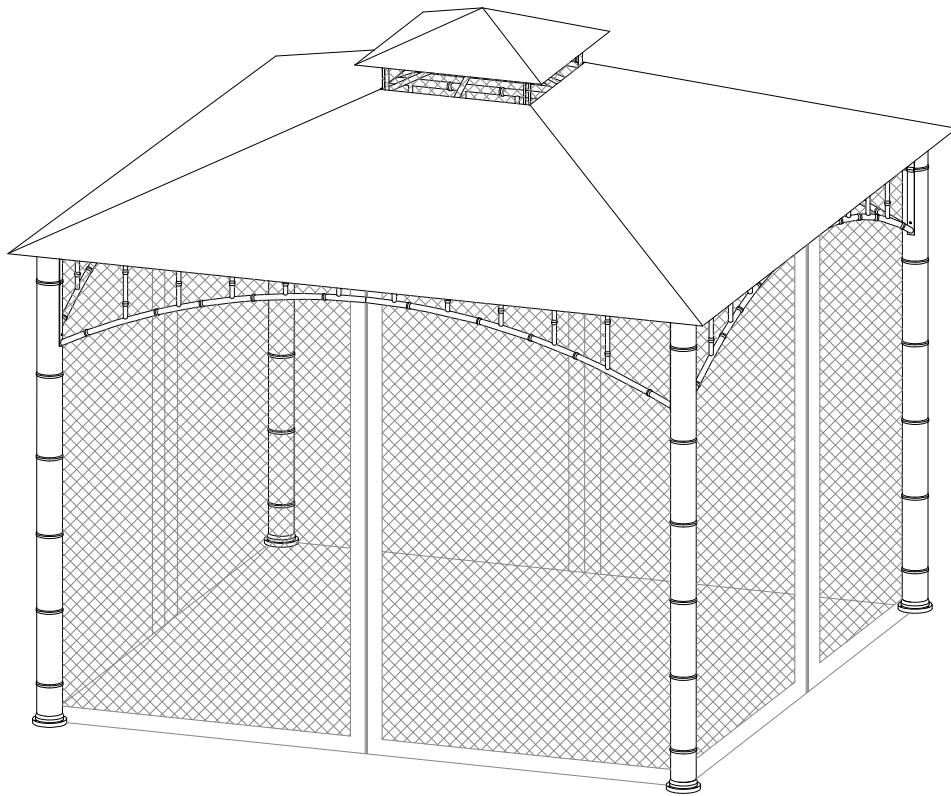




## Assembly Instructions

088-0342-8

### havana gazebo

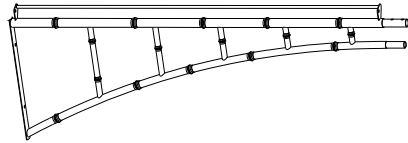
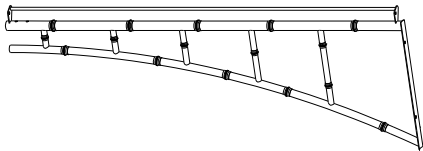
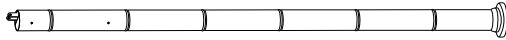
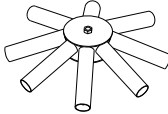
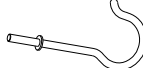

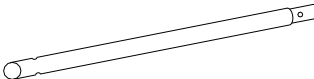
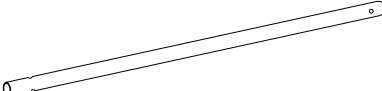
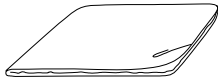
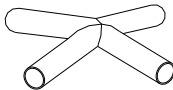
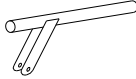





#### **WARNING**

In order to reduce the risk of personal injury and damage to equipment, basic safety precaution should always be followed when assembling and using this product. Read all instructions carefully before assembly and use.

- Some parts may contain sharp edges. Wear protective gloves if necessary.
- In order to ensure safe assembly, it is recommended that this product be assembled by at least two people.
- Keep children and pets away from the assembly area.
- Begin the assembly at least 6' (1.8 m) away from any obstruction, such as a fence, garage, house, overhanging branches, laundry line, or electrical wires.
- Install this gazebo on level ground. This gazebo cannot be permanently stacked or attached to a concrete floor or platform. This gazebo is intended for decorative and sunshade purposes only, and is not designed to withstand harsh weather, including high winds, rain, and snow.
- Verify that all nuts and bolts are tightly secured before and during use.
- Remove the canopy or take other precautions in high wind conditions.
- Anchor or stake a minimum of four (4) locations of the unit to the ground for added safety and security.

## Parts List

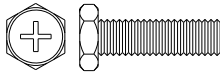

4 pieces	1A	Left Frame	
4 pieces	1B	Right Frame	
4 pieces	1C	Column	
1 piece	2A	Top Connector for the second roof	
1 piece	2B	Hook	
4 pieces	2C	Short Bar for the second roof	
4 pieces	2D	Medium Bar for the second roof	
4 pieces	2E	Long Bar for the second roof	
1 piece	3A	Canopy for the second roof	
1 piece	3B	Top Connector	
4 pieces	3C	Small Top Pole	
1 piece	3D	Canopy for top roof	
1 piece	3E	Mosquito Netting	
40 pieces	3E1	Plastic Ring	

**Tools required: Hammer, Ladder, Screwdriver (not included)**

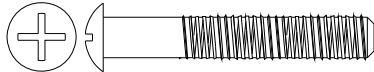

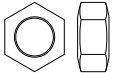
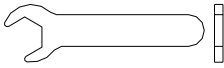
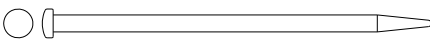
## Hardware Identification

For ease of identification all hardware is organized into separate Hardware packs for each Hardware type in the Instruction Manual.

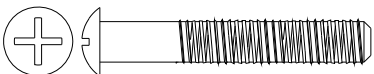

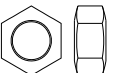
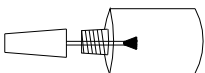
### Hardware Pack 1

28 pieces	(AA) M6×20 screw TBZ01406020HQ	
28 pieces	(BB) M6 big flat washer TBZ10806HQ	

### Hardware Pack 2

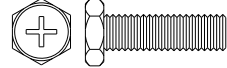

8 pieces	(CC) M6×40 screw TBZ00306040HQ	
8 pieces	(BB) M6 big flat washer TBZ10806HQ	
8 pieces	(DD) M6 nut TBZ20106HQ	
1 piece	(WW) M6 wrench	
12 pieces	(GG) Stake TBZ10608180HQ	

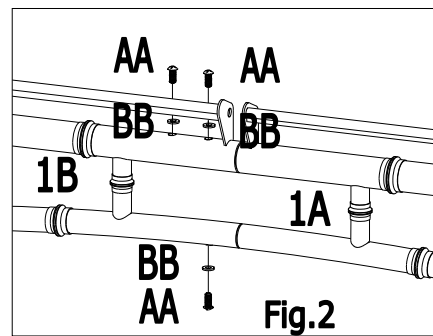
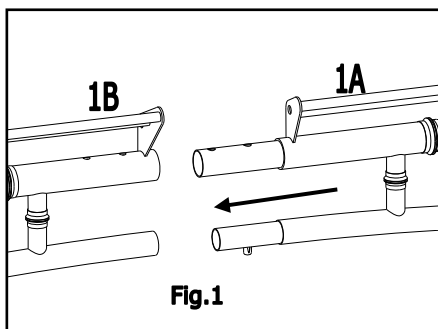
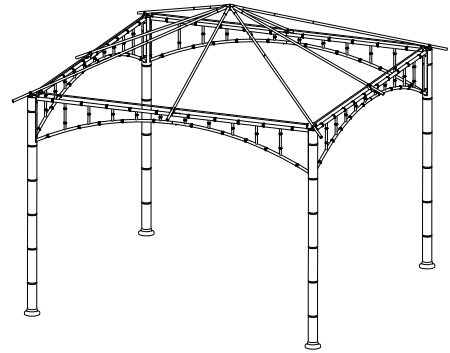
### Hardware Pack 3

4 pieces	(CC) M6×40 screw TBZ00306040HQ	
4 pieces	(BB) M6 big flat washer TBZ10806HQ	
4 pieces	(DD) M6 nut TBZ20106HQ	
1 piece	(HH) Touch up paint	

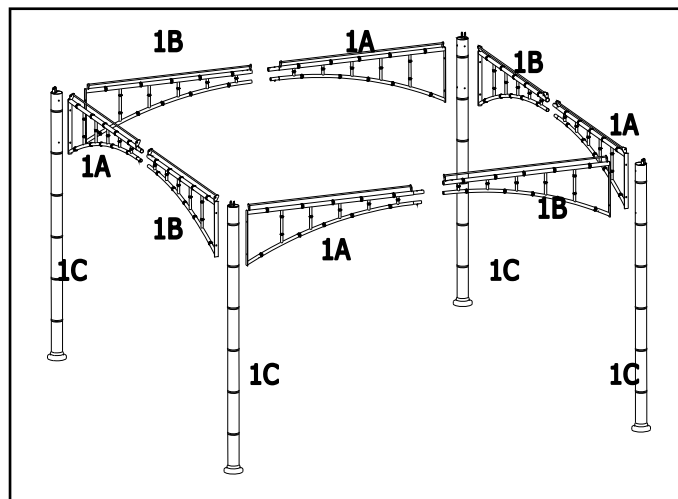
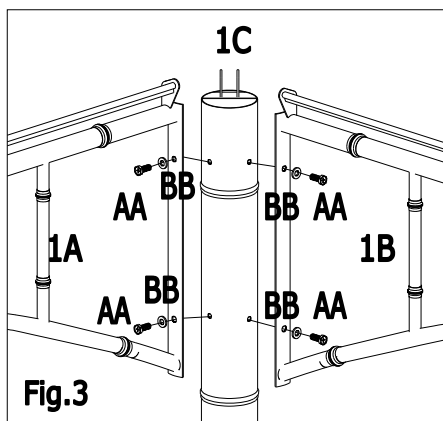
# STEP #1

## Columns

(x28)	(AA)	
(x28)	(BB)	



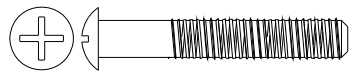




**Fig.1, Fig.2:** Insert each Left Frame (1A) into Right Frame (1B) to form four side screens around, and secure them by using Screw AA and Washer BB.

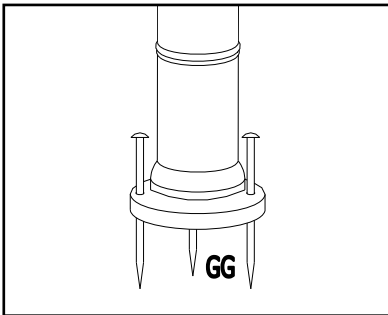
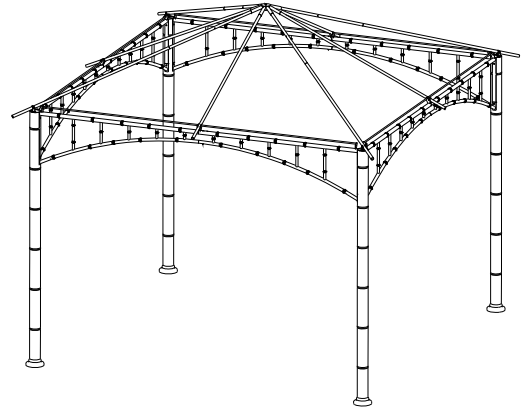


**Fig.3:** Attach the assembled screens onto four Columns (1C) by using Screw AA and Washer BB, to get a complete frame.

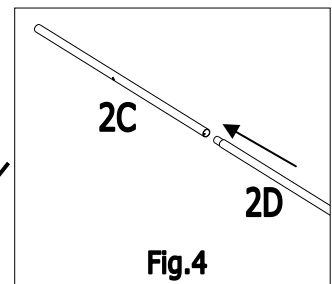
# STEP #2

## The second roof

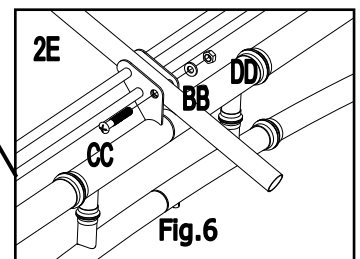
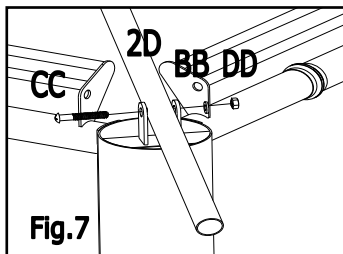
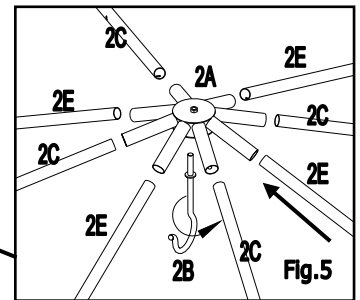
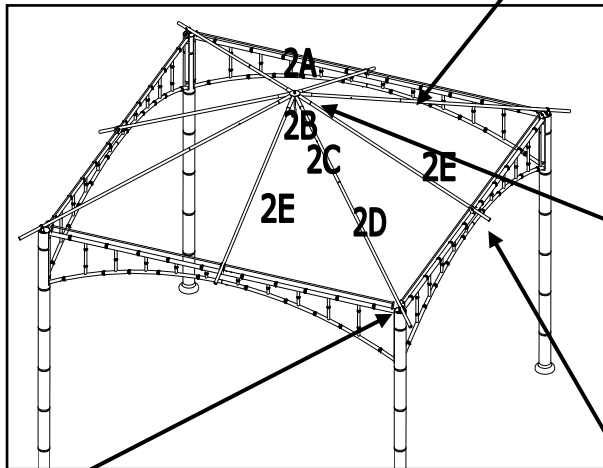
(x 8)	(CC)	
(x 8)	(BB)	
(x 8)	(DD)	
(x 1)	(WW)	
(X12)	(GG)	



**Fig.4:** Insert one end of Medium Bar for the second roof (2D) into one end of Short Bar for the second roof (2C).



**Warning:** Secure the assembled frame on the ground by using Stake (GG), before following steps which require a ladder.



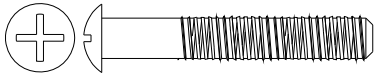

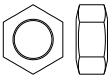
**Fig.5:** Screw Hook (2B) into Top Connector for the second roof (2A) tight; Insert the other end of 2C into 2A; Insert one end of Long Bar for the second roof (2E) into 2A.

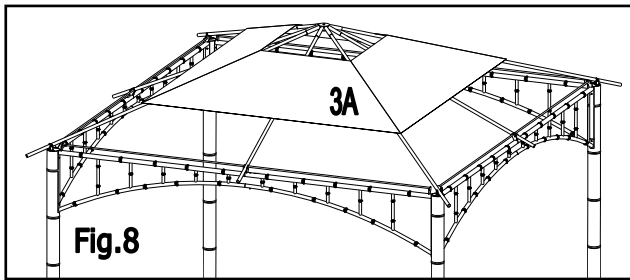
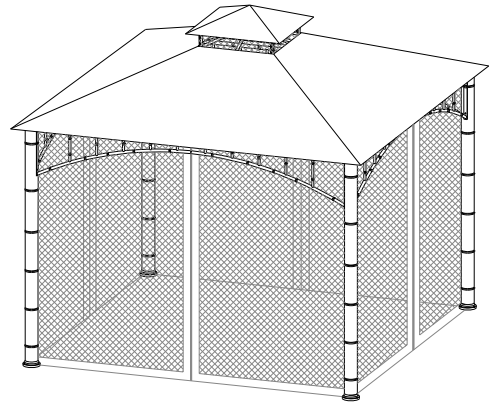
**Fig.6:** Tighten the other end of 2E with screen by using Screw CC, Washer BB and Nut DD.

**Fig.7:** Tighten the other end of 2D with column by using Screw CC, Washer BB and Nut DD.

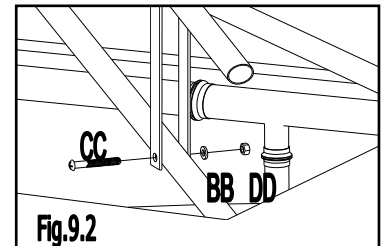
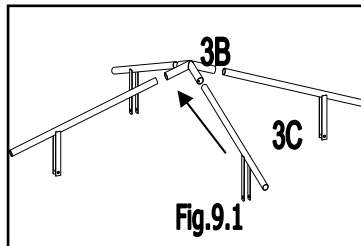
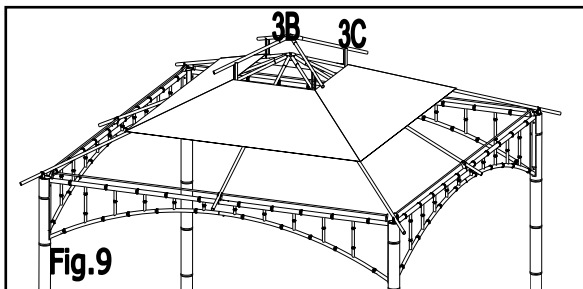
# STEP #3

## Top roof, canopy and mosquito net

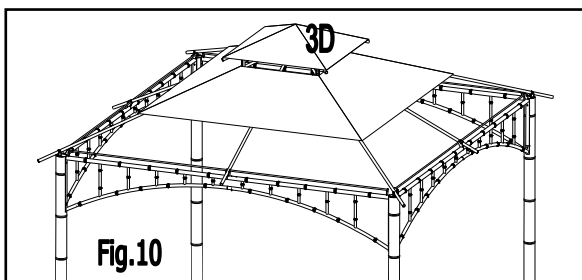
(x 4)	(CC)	
(x 4)	(BB)	
(x 4)	(DD)	



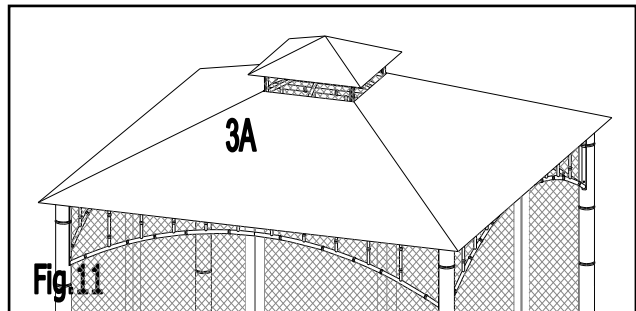
**Fig.8:** Put Canopy for the second roof (3A) onto top roof. Do not complete it here in order to assemble the second roof.



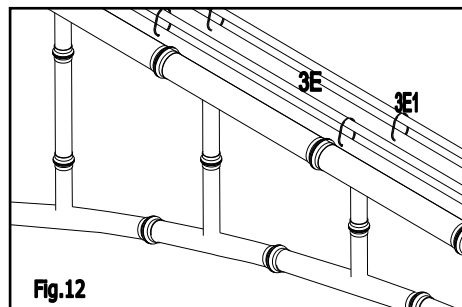
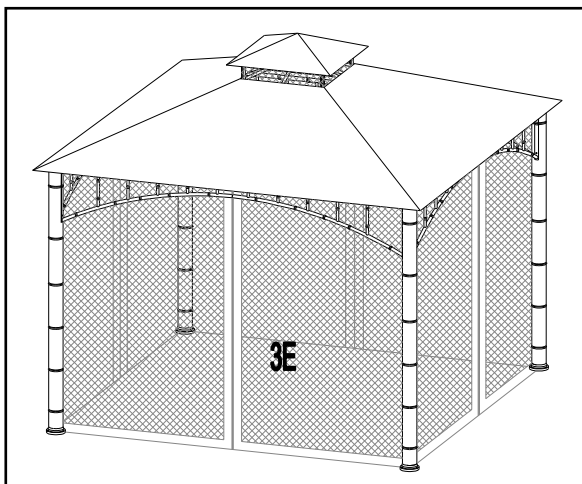
**Fig.9:** Insert Small Top Pole (3C) into Top Connector (3B), then use screws CC, washers BB and nuts DD to secure 3C and bars on the second roof.



**Fig.10:** Complete fitting Canopy for top roof (3D).



**Fig.11:** Complete fitting Canopy (3A).



**Fig.12:** Hang the mosquito netting onto the outside tracking pipe by using Plastic Ring (3E1).

**Note:** The inside tracking pipe is for hanging privacy panels use. Privacy panels are sold separately.

## **Care & Maintenance**

Steel components of garden accessories and furniture are treated with rust inhibiting paint that protects them from rust. However, due to the nature of steel, surface oxidation (rusting) will occur if this protective coating is scratched. This is a natural process. To minimize this condition, it is recommended that care be taken when assembling and handling the product, in order to prevent the paint from being scratched. If scratching or damage occurs, it is recommended that the area be touched up immediately with rust inhibiting paint, which is included in the package. Surface rust can be removed easily using a very light application of common cooking oil. If surface oxidation (rusting) occurs and no measures are taken to correct it, the oxidation may start dripping onto the deck or patio, which may cause damaging stains that may be difficult to remove.

**Imported by Trileaf Distribution Trifeuil Toronto, Canada M4S 2B8**